

# User Manual for phædrus

phædrus-audio.com

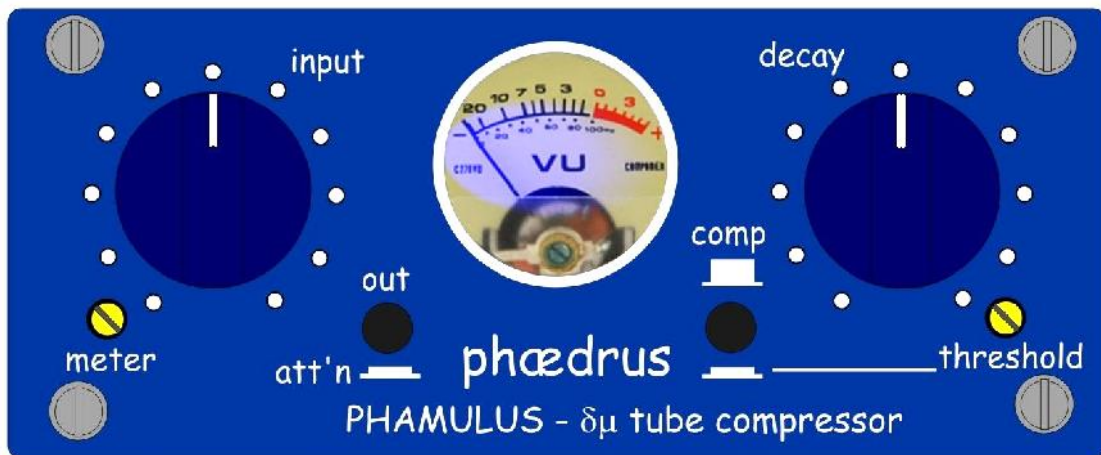

## PHAMULUS – $\mu$ tube compressor

*FAMULUS n. (pl, ~li) the attendant of a sorcerer*

This manual is also available as a pdf download, Go to: [www.phaedrus-audio.com](http://www.phaedrus-audio.com)

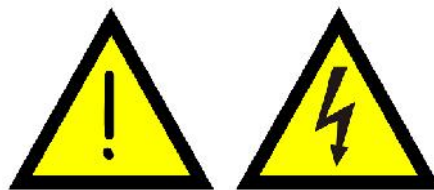

RISK OF ELECTRIC SHOCK  
DO NOT OPEN!

## Preface - About Phædrus Audio



Phædrus Audio was formed to design, manufacture and sell high-quality products for the professional and semi-professional audio market. Phædrus Audio's founders remain inspired by the music and the recording practices of the fifties and sixties, and are motivated to re-establish the values of the great audio-technology legends of the past with their ideals of transparency, hand-built quality, and serviceability. Using modern manufacturing techniques and the benefits of modern component technology, Phædrus Audio's aim is to reproduce the quality and character of classic equipment but in a modern, highly reliable, and cost-effective way.

## Chapter 1 - Background

The Phædrus Audio products came about because two, recording musicians wanted to own "classic" audio gear from the nineteen-sixties. The PHAMULUS is a continuation of that ambition: a high-quality compressor based on the Altec 436C compressor.



The Altec 436C

### **Construction - or star earths (grounds) and curly tracks**

Given their vintage, the Altec 436Cs were built on a metal chassis, with the components hardwired onto the valve (tube) bases and tag-strips. Although Phædrus Audio equipment uses printed circuit boards to ensure consistent performance and reliability, the equipment follows "classic" practices such as star earths and "natural contour" tracking, just like hook-up wire.

Every Phædrus Audio product is hand assembled and individually tested. A test pro-forma is provided with every unit. Phædrus Audio offer comprehensive service for products both inside and outside of their warranty period.

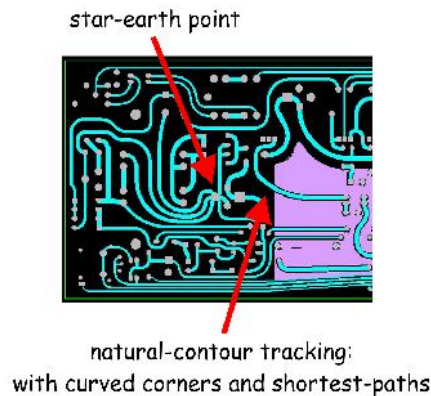

## Chapter 2 - Warranty and Service

Please register your purchase with Phædrus Audio at [www.phaedrus-audio/registration.htm](http://www.phaedrus-audio/registration.htm) . This will simplify service & repair should you need this service. Your name will be placed on our mailing list (unless otherwise requested) for future updates and new product announcements.

### Service

If you experience a problem with a Phædrus Audio Ltd. product, contact:

support@phaedrus-audio.com  
TELEPHONE: +44 207 193 4609  
Skype ID: phaedrusaudio

We will diagnose the problem remotely and advise you of the warranty status. If a repair or replacement is required, we will issue a Return Merchandise Authorization (RMA) number and tell you where to send the unit to be repaired. You **MUST** have an RMA number before you return the equipment to Phædrus Audio Ltd.'s support service. Be sure to write RMA number on outside of shipping box and to include your name, address, phone number, a copy of original sales invoice and a detailed description of the problem. Phædrus Audio Ltd. will not accept responsibility for loss or damage in shipping or for equipment returned without valid paperwork and/or a valid RMA number. Remember, warranty is void if product serial numbers have been removed or altered, or if the product has been damaged by abuse, accident or unauthorized modification and/or repair (see Phædrus Audio Ltd. Limited Warranty for details). There are no user serviceable parts inside.

PLEASE RETAIN YOUR SALES RECEIPT. IT IS YOUR PROOF OF PURCHASE COVERING YOUR LIMITED WARRANTY. LIMITED WARRANTY IS VOID WITHOUT SUCH PROOF OF PURCHASE.

## Phædrus Audio Ltd.'s Limited Warranty

This limited warranty is valid only if you purchased the product from Phædrus Audio Ltd. or from a Phædrus Audio authorized dealer in the country of purchase; a list of authorized dealers can be found on Phædrus Audio website [www.phaedrus-audio.com](http://www.phaedrus-audio.com), or by contacting [sales@phaedrus-audio.com](mailto:sales@phaedrus-audio.com). Phædrus Audio Ltd. warrants that the equipment it manufactures shall be free from defects in material and workmanship for a period of one (1) year from the original date of purchase; unless a longer minimum warranty period is mandated by applicable local laws. If equipment fails due to such defects within this period, Phædrus Audio will, at its option, repair or provide a replacement for the defective part or product. Valves (vacuum tubes) are excluded from the one-year warranty, but are warranted for 90 days from day of purchase. This warranty does not extend to any Phædrus Audio Ltd. product that has been damaged or rendered defective as a result of: accident, misuse, or abuse; or by the use of parts not manufactured or supplied by Phædrus Audio Ltd.; or by unauthorized modification or attempted repair to the product; or by acts of God/Nature (accident, fire, flood, etc) or any other condition that is beyond the control of Phædrus Audio Ltd. There are no user serviceable parts inside. This limited warranty is invalid if the factory-applied serial number has been altered or removed from the product. This limited warranty is extended exclusively to the original buyer (customer of Phædrus Audio Ltd., or authorized retail dealer) and is not transferable to anyone who may subsequently purchase the product. No other person (retail dealer, etc.) shall be entitled to give any warranty promise on behalf of Phædrus Audio Ltd. Phædrus Audio Ltd. makes no other warranties, expressed or implied, of merchantability, fitness for a particular purpose or otherwise. Phædrus Audio Ltd. liability is limited to repair or replacement by Phædrus Audio Ltd., at its sole discretion and, in no event, will Phædrus Audio Ltd. be liable for any direct, indirect, special, incremental or consequential damages resulting from any defect in the product, including lost profits, damage to property and, to the extent permitted by law, damage for personal injury, even if Phædrus Audio Ltd. has been advised of the possibilities of such damages.

## Shipping Charges

For any hardware defects experienced by the customer while the product is under warranty, Phædrus Audio Ltd. will incur the shipping cost to the customer and the customer is responsible for the shipping costs to Phædrus Audio Ltd's designated after-sales service office. For defective products that are out of warranty the customer is responsible for all shipping costs to and from Phædrus Audio Ltd's designated after-sales service office.

## Extended warranty and out-of-warranty services

Various services are available from Phædrus Audio Ltd. These include repair services for equipment once the warranty period has expired, and the ability to extend the warranty period. These are:

**PHAMULUS-REP** - Repair of a defective PHAB preamp', charged at a flat-rate

**PHAMULUS-MISEAJOUR** - Mise à jour for PHAMULUS\*

**PHAE-EXTWARR** - Extends standard warranty (see above) by a further year\*\*

\* A mise à jour service includes a complete inspection, re-valve (re-tube) and the implementation of any engineering updates as well as a re-test to performance specification.

\*\*If extended warranty is ordered after the initial warranty has expired then the intervening period is charged without exception.

Please contact your dealer or Phædrus Audio Ltd. for current prices.

Warranty service conditions are subject to change without notice. For the latest warranty terms and conditions and additional information regarding Phædrus Audio Ltd. limited warranty, please see complete details online at [www.phaedrus-audio.com](http://www.phaedrus-audio.com).

# Chapter 3 - Safety

## General

Before using any piece of equipment manufactured by Phædrus Audio Ltd., be sure carefully to read the applicable items of these operating instructions and the safety suggestions. Keep them for future reference. Follow the warnings indicated on the unit, as well as in the operating instructions.

## Selection of PSU

Suitable PSUs for the Phædrus Audio Ltd. products are available as line items from Phædrus Audio.

They are:

**PHAE-PSU(110)** - 110V mains plugtop PSU; plug is North American type.

**PHAE-PSU(220Euro)** - 220V mains plugtop PSU; plug is European type

**PHAE-PSU(220UK)** - 220V mains plugtop PSU; plug is 3 pin 13 AMP, British type

A 12V AC supply is required for the Phædrus Audio PHAB, PHAME and PHI units. A direct current (DC) supply is NOT suitable and will damage the unit. If a supply is sourced elsewhere than from Phædrus Audio, it must have the following specifications:

- 12V AC, 12 Watt supply or greater ( $>$  or  $=$  1000mA supply current)
- Must be suitable for connection to the appropriate mains voltage
- Must be Class-II, double-insulated
- Must have 30% regulation or better
- Must contain one-shot thermal fuses, resettable fuses, or Polyswitches for over-current protection.

UK and Euro units should comply with **EN 60950-1** and **CE** requirements and **only PSUs with UL and CSA** approvals should be provided on North American units. Units supplied to other countries should be verified to comply with the relevant standards which obtain in those territories.

## User Access & Servicing

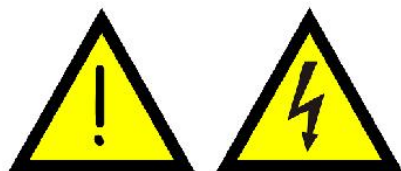

RISK OF ELECTRIC SHOCK  
DO NOT OPEN!

Phædrus Audio equipment employs thermionic valve (vacuum-tube) technology and employs hazardous voltages for the high-tension supplies. **THE USER SHOULD NOT ATTEMPT TO SERVICE THE UNIT. ALL SERVICING SHOULD BE REFERRED TO QUALIFIED SERVICE PERSONNEL OR FACTORY ONLY.** Phædrus Audio products should **NEVER** be connected to the external power supply or in any other way energised when the

case is opened and/or the circuit board is accessible.

## Ground (earth) issues

Phædrus Audio Ltd.'s products are all powered by external (12V AC) power supplies which should be double insulated, class-II types (see above). It should therefore be appreciated that,





A CONNECTION TO EITHER THE PHAB, the PHAME, PHILTER or the PHI product CAN NEVER BE RELIED UPON PROVIDE A PROTECTIVE OR SAFETY EARTH (GROUND). This advice obtains IRRESPECTIVE OF THE SETTINGS OF ANY "EARTH OR GROUND LIFT" SWITCHES.

## General Safety Instructions

- Do not operate Phædrus Audio equipment near any source of water or in excessively moist environments.
- Keep your Phædrus Audio equipment away from babies, children and pets.
- Do not let objects do not fall, or liquids be spilled, into the enclosure.
- Situate the Phædrus Audio equipment away from heat sources or other equipment that produce heat.
- Ensure Phædrus Audio equipment has adequate ventilation. Improper ventilation will cause overheating, and can damage the equipment.
- When cleaning Phædrus Audio equipment, remove all connections to the unit; including power and gently wipe with a clean lint-free cloth; if necessary, gently moistened with lukewarm or distilled water. Use a dry lint-free cloth to remove any remaining moisture. NEVER use aerosol sprays, solvents, or abrasives on Phædrus Audio equipment.
- Phædrus Audio equipment should be serviced by qualified service personnel or returned to Phædrus Audio Ltd. when: an object (or objects) have fallen into the enclosure; or liquid has fallen into, or been spilled into the unit; or the unit has been exposed to rain or high humidity; or the unit does not operate normally or exhibits a marked change in performance; or the unit has been dropped, or the enclosure has been damaged.

## Chapter 4 - About Valves (Vacuum Tubes)

### Valve (tube) types

#### 12AU7 or ECC82

The 12AU7 is a popular, miniature 9-pin medium-gain dual triode valve (tube) and is used in many instrument and hi-fi amplifiers. Both triodes are used, in cascade, in the Phædrus Audio PHI product. The 12AU7 is also known in Europe under its Mullard-Philips tube designation ECC82. This tube is widely available both new and NOS and a number of special quality equivalents are available. Current production of 12AU7 takes place in Russia, Slovakia, and China. Phædrus Audio selects and recommends the long anode (plate) version of the ECC82 (ECC802S) or 12AU7 valve for application in the PHI DI-Box.

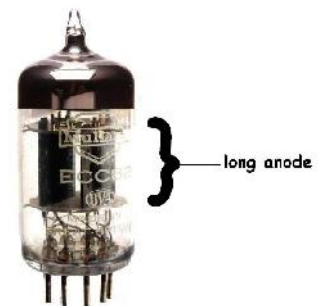

#### 6BC8 and 6BZ8 tubes

The tube chosen for the "vari-mu" ( $\delta\mu$ ) element in the Phædrus Audio PHAMULUS is the 6BC8/6BZ8 tube. This was the tube in the original Altec circuit. The 6BC8/6BZ8 tubes are medium-mu, semi remote cutoff twin triodes, originally intended for applications in television receivers. Because these tubes arrived late in the "age of thermionics" and were employed in the most successful consumer product of all time (the television), there exist many, many of these tubes as NOS (new old stock) at reasonable prices. This underlies Phædrus Audio's decision to adopt this tube.

## Valve (tube) lifetime

You should replace the valves in the tubes in the Phædrus Audio products only when you start to notice changes in the sound quality. If the gain of the preamplifier decreases noticeably, then this is certainly evidence of the onset of valve (vacuum tube) failure. Before this, the tone may become "dull" and transients may become "blunted".

That said, the lifetime of a valve (tube) is largely determined by the lifetime of its cathode emission and the small-signal valves (tubes) used in the PHAB, PHAME, PHILTER and PHI use oxide cathodes, which can provide adequate cathode emission for 100,000 hours or more. That's over eleven years of continuous use. So do not replace valves (tubes) just because they have seen a few years of service.

Phædrus Audio Ltd. can provide suitable valves (tubes) as spares which, after a burn-in period, are screened for best performance in your Phædrus Audio product. These are available as line items:

**PHAE-12AU7** - Selected 12AU7/ECC82 type valve

**PHAE-ECC88** - Selected ECC88 type valve

**PHAE-EF86** - Selected EF86 type valve

**PHAE - 6BC8** - Selected 6BC8 type valve

Please contact your dealer or Phædrus Audio Ltd. for current prices.

## Chapter 5 - Instructions for use

Phædrus Audio's products employ valves (vacuum tubes) as the **ONLY ACTIVE DEVICES** in the audio path. Valves (vacuum tubes) and their associated circuitry need time to reach an electronic equilibrium before they will operate at optimal specifications. Please therefore allow these products to warm up for, at least, 5 to 10 minutes before using them in your signal chain. To prolong the life of your valves (tubes), it is recommended that you turn off these units when not in use.

### Connecting the PHAMULUS

The PHAMULUS is a line-level device designed to be used at standard professional audio levels of 0VU = +4dBu. The input is "bridging" or high-impedance. The output is low impedance. The PHAMULUS uses a push-pull tube amplifier for its output stage (just like a little tube power-amp'), so it **MUST** be operated into the correct load of 600 ohms. Because most modern equipment provides for high-impedance inputs, Phædrus Audio has chosen to install the 600 ohm load within the PHAMULUS unit. (In fact it forms part of the output attenuator - more about this below.) If you do **NOT** require the load to be installed internally, speak to Phædrus Audio or your local representative.

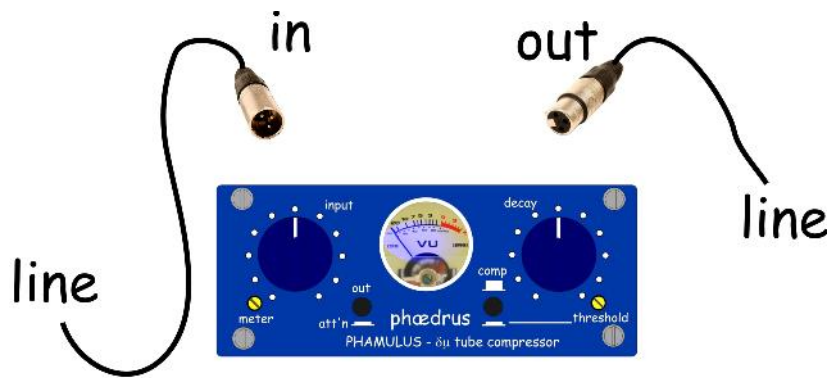

## PHAMULUS

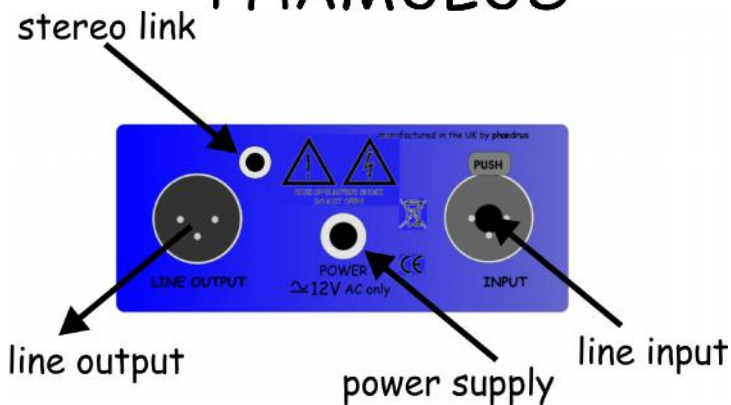

Typical connection set-up for the PHAMULUS

## Introduction - Compressors, Limiters and "Limiting Amplifiers"

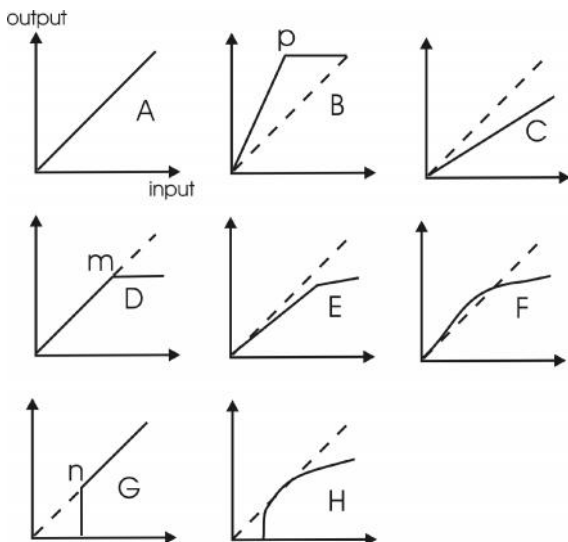

Compressors and limiters enjoy a fundamental similarity. In a limiter, the knee of the compression curve (the threshold) is set way up the transfer function, after which a very high degree of compression is imparted on the input signal (curve D in illustration). In a compressor, a lower degree of compression (compression ratio) is imparted at a lower threshold (curve E). Most modern compressors provide controls to adjust both compression threshold and ratio, so it is logical to speak of these units as compressor/limiters because they can function as either.

However in older tube-based units, such as the equipment the Phædrus Audio PHAMULUS is based upon, these functions are combined in a gradual characteristic (curve F). The user operation of this equipment therefore largely relies on how "hard" the equipment is driven to alter the dynamic range of the incoming signal. By applying low-level drive - by means of reducing the drive via the input attenuator - this equipment will only impart a gentle compression characteristic.



By driving the equipment with a high-level signal (by simply advancing the "input" level control), more and more of the dynamic range will be compressed.

In fact, the distinction between the term "limiter" and "compressor" was not well defined until the nineteen-seventies, so you will often find classic compressors were referred to by their manufacturers as "limiters", "limiting amplifiers" or "compression amplifiers".

## Vari-mu compressors: the Altec Lansing 436 and the EMI RS124

The most famous classic tube-based compressors are of the vari-mu family in which advantage is taken of technology developed for automatic-gain-control (AGC) for radio equipment. In a radio set, the radio-wave strength may vary due to reflections and obstacles; this being especially true for mobile radios in cars and aeroplanes. With amplitude modulation (AM) radio, this is problematic, because a change in the signal strength causes a change in detected output and thereby reproduced volume and this is very disturbing to the listener. This was a major problem with early "wireless sets" and a solution was eagerly researched.

The solution to the problem came in the shape of a post-detector, filter circuit with a time-constant long enough that it removed all the audio modulation and left just an overall DC voltage value dependent on the average amplitude of the RF carrier. This signal was then used to adjust the gain of the radio frequency (or intermediate frequency) amplifiers prior to detection. By this means, the overall value of the radio carrier was held steady and the volume of the detected modulation always remained that of the broadcast signal. How was the variable-gain accomplished? The answer lies in the inherent non-linearity of the valve (tube) which is deliberately exploited in radio valves to offer the AGC function.

All valves (tubes) have a power-law transfer-characteristic. That is to say that a given change in grid voltage does not result in an equal change in anode current over the operating range of the valve. By arranging the RF carrier to work only over a proportion of the overall characteristic and "sliding" the incoming signal over the entire operating characteristic, it is possible with any valve to derive a measure of variable gain, as illustrated below.

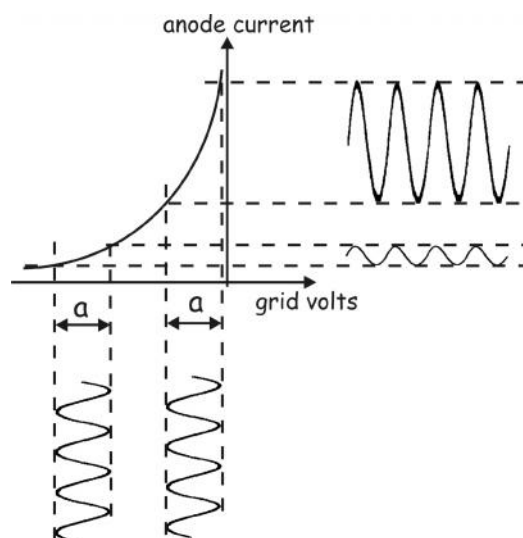

Suppose that - for the moment - the radio set is receiving a strong signal. In this circumstance, the filtered AGC control voltage taken after the detector is large and this is so arranged to

"slide" the input signal to the left-hand portion of the curve in the figure above. If the signal level drops, initially, the volume of the signal drops too. But, in a fraction of a second (the usual control delay is about 1/4 of a second), the AGC control voltage falls and biases the operating range of the valve to the right of the characteristic, thereby restoring the RF level, and with it, the recovered audio. So important was this development in radio sets, that radio valves are especially designed to maximise the curvature of the transfer-characteristic, these types of valves being known as "vari-mu" valves: the  $\mu$  (mu) relating to the coefficient of gain.

Another term for vari-mu is "remote cut-off" which describes the fact that the cut-off point for the valve (the negative voltage at which the anode current ceases), is made as "remote" as possible from 0V, thereby prolonging the curvature of the  $V_g/I_a$  characteristic. The alternative to "remote cut-off" valve is a "sharp cut-off" device. Audio valves are "sharp cut-off" types; which means that the  $V_g/I_a$  characteristic is made as linear as possible. This is one of the reasons why radio valves make poor devices for audio applications.....except as the basis for compressors!

Of course, we might justifiably call "volume compression" by the equally valid term "audio automatic-gain-control" or "audio-AGC", so it is not surprising that the earliest compressors adopted the radio technology and applied to audio signal circuits. The only difference between a volume compressor and an AGC circuit is that - in the case of the former - it is the audio signal itself which is rectified and used as the control signal, rather than the modulated carrier.

## Altec Lansing 436C



The Altec Lansing 436C compressor amplifier (above) dates from the nineteen-sixties. The circuit design of the Phædrus Audio PHAMULUS is based upon this circuit.

## EMI RS124

A famous, but rare, EMI-developed variant of the Altec Lansing 436 exists which included a modification to the input circuit to include a matched-impedance attenuator and added an output attenuator (both designed to operate at EMI's quaint, 200 ohm interface-standard). Importantly, from an artistic point of view, the original Altec circuit only included a variable release time preset ("RELEASE"), so this was added as a user-control by the EMI engineers, This greatly increased the scope of the compressor's duties to which has been attributed some Beatles' magic. The entire unit was retro-fitted with an EMI-designed escutcheon which (thinly) disguised its Altec heritage.

EMI's variable release user control has been adopted in the design of the Phædrus Audio PHAMULUS such that the control allows for adjustable release times between 0.1 sec (much faster than the original Altec) and 1.3 sec. This faster response widens the applications of the Phædrus Audio PHAMULUS to include compression duties for - amongst other things - drums.

## PHAMULUS Front panel controls

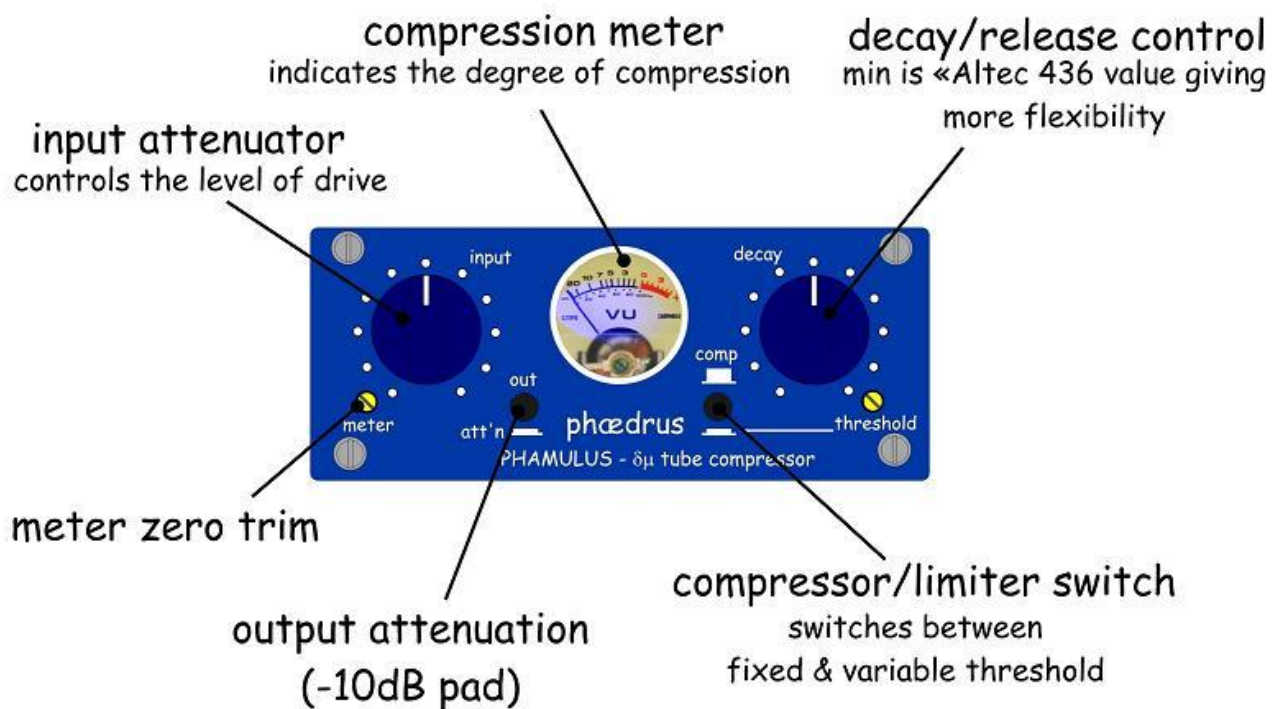

The PHAMULUS front panel

The front panel controls of the PHAMULUS, and their application, are illustrated in the diagram above.

## Controls

### Input Gain Control

This control is used to adjust the input level to provide the desired average compression as indicated on the compression meter

### Release Control

The time interval required to restore full gain following a condition of compression is adjustable in the range of 0.1 seconds to 1.3 seconds by means of this control.

### Output attenuator

One criticism often levelled at the Altec 436 is that its output level is very "hot"; making it difficult to interface with other equipment. This is a valid criticism and the EMI engineers wisely added an output attenuator to the Altec chassis for the RS124. The PHAMULUS also incorporates a controlled-impedance attenuator (at a fixed 10dB attenuation), selectable by a front-panel push-switch.

### Compression meter

The compression meter indicates the average degree of compression being applied to the signal in dB. Of course, your ears are the judge, but this indicator will help you to find the optimum degree of compression to be applied to your track or mix.

### Comp/ threshold switch and threshold preset

Note that the Phædrus Audio PHAMULUS also features a front-panel push-switch which enables quick selection between a factory-set threshold level ("compressor" position), and a variable threshold level (via the right-hand preset, labelled "limiter position). On shipping, the threshold preset is set at its maximum which - if never adjusted again - gives a simple way of switching between two regimes one ("compression") suited for tracking; the other (switch depressed) more suited for mastering or applying over a sub-mix. Alternatively, with the switch depressed, the "threshold" preset control may be adjusted for greater flexibility.

The compressor characteristics (as shipped) are illustrated in the figure below. Adjusting the "threshold" preset gives a family of characteristics between these two extremes.

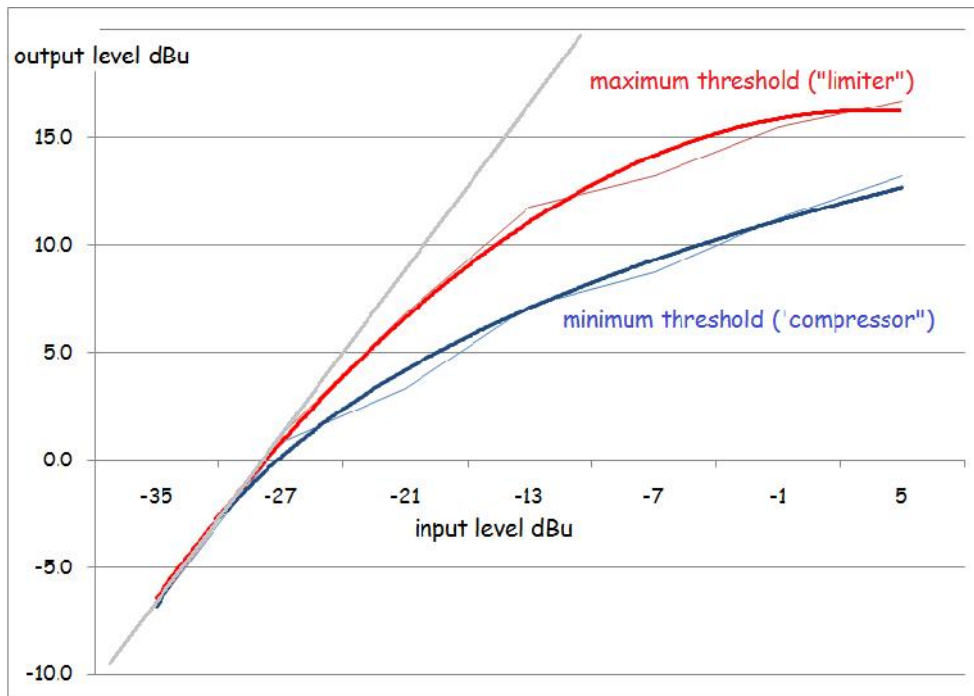

Alternatively, because we are here talking of a "vari-mu" (variable-gain) compressor, it's instructive to see these characteristics in terms of gain at various input levels (measured using static 1kHz tones). This is illustrated here.

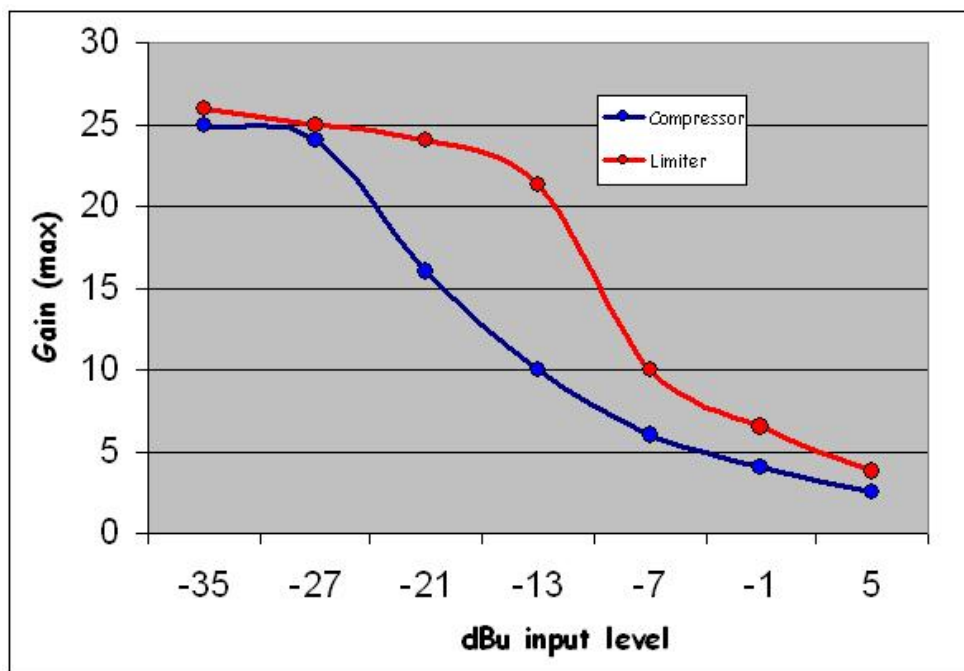

The dynamic response of the PHAMULUS is illustrated in the oscillogram below.



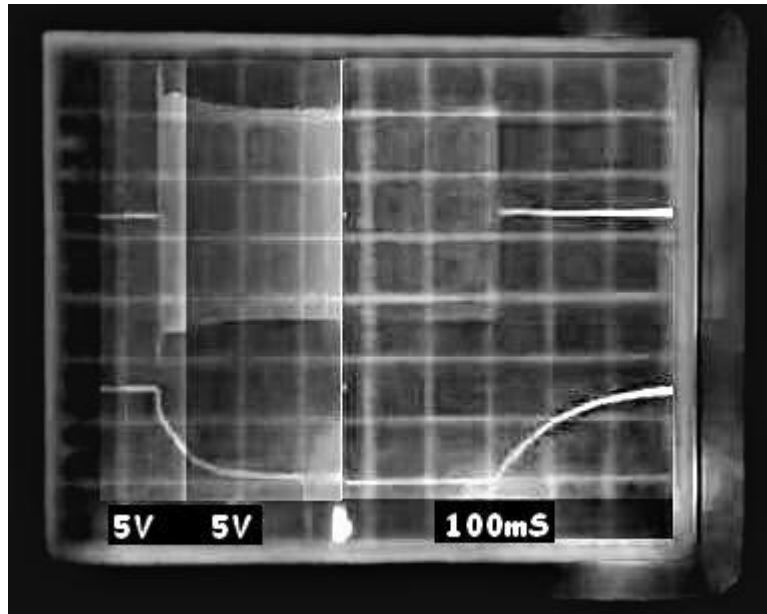

## Meet the PHAMULI



Phædrus Audio PHAMULI

The Phædrus Audio PHAMULUS has a unique stereo link feature, meaning that two PHAMULI (yes, that's the real plural form of PHAMULUS) may be linked together to form a stereo compressor. Ideal for mastering duties and adding that final "magic"! When ordering a PHAMULI, you will be supplied with a special link cable which should be installed between the two units and connected to the "stereo link" connector on each unit. One unit will operate on the LEFT channel: the other on the RIGHT channel.

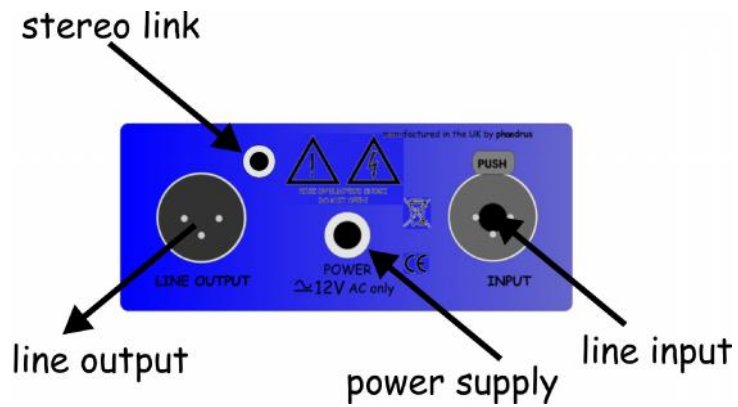

## Stereo Operation

When operating the PHAMULI as a stereo pair, carefully match the "input" control setting on the two units for a balanced stereo image that isn't "pulling" to one side. The setting of the "comp"/"threshold" switch must be consistent between both units too, and - if depressed - the "threshold" pres-sets should be set to similar settings. The "Decay" controls interact, so that the knob which is set to the LOWER setting (fastest response time) will predominate.

## Chapter 6 - Circuit description

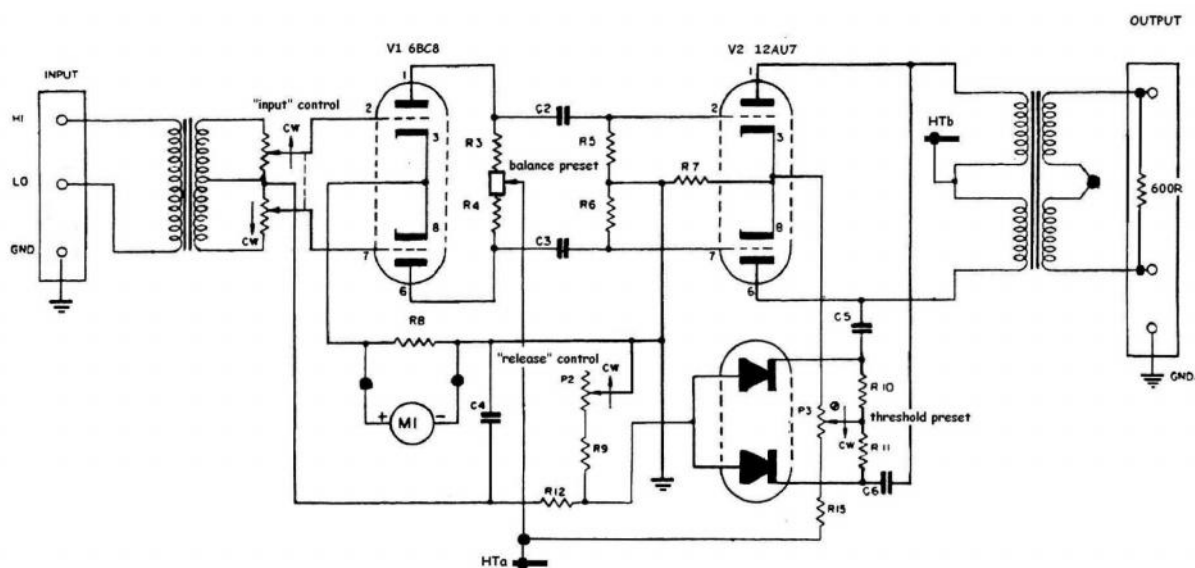

The Phædrus Audio PHAMULUS circuit works like this: large negative signal peaks on the anodes of the push-pull output stage V2 cause double-diode V3 to conduct and drag down the bias volts to the input stage V1. This action is damped by the time-constant formed by R9, P2 and C4 which allows for some adjustment of the compressor's release time. The level threshold, at which the compression action is required, is adjustable too; by means of the simple expedient of biasing the cathodes of the double-diode V3 with a constant bias derived from the slider of P3. The compression action is obtained because, as signal peaks depress the bias volts on V1, the stage "slides" further down the input valve's curved  $V_g$ - $k/I_a$  characteristic: the required voltage change for a given change in anode current is reduced and the stage-gain is lowered. The compression control-signal itself remains inaudible because it is applied equally to both input valves: whereas the music signal is applied differentially - in other words, the common-mode control-signal is cancelled out in the differential amplifier.

# Specifications

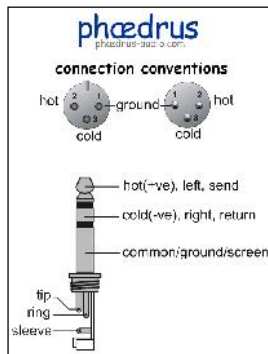

## Electrical connections

### Input:

Unbalanced: 3 pin XLR Connector

Pin 1 - Ground

Pin 2 - (+) Signal

Pin 3 - Connect to Pin 1

Balanced: 3 pin XLR Connector

Pin 1 - Ground

Pin 2 - (+) Signal

Pin 3 - (-) Signal

### Output:

Unbalanced: 3 pin XLR Connector

Pin 1 - Ground

Pin 2 - (+) Signal

Pin 3 - Connect to Pin 1

Balanced: 3 pin XLR Connector

Pin 1 - Ground

Pin 2 - (+) Signal

Pin 3 - (-) Signal

## PHAMULUS Specification

Type: Compressor Amplifier

Gain: +30dB (reduced to +20dB with output attenuator engaged)

Frequency Response:  $\pm 1.5$  dB, 40Hz to 15kHz

Max Output Level:  $\gg +20$  dBu (as straight amplifier at 1kHz)

Harmonic Distortion: At 25 db of compression: Less than 1.5%

Noise Level: 74 dB below rated output ( $-111$  dBm equivalent input noise)

Input Impedance: 15k bridging transformer (earth-free)

Load Impedance: Normally bridging: 600 ohms if ordered specially

Maximum Compression: 30 dB

Attack Time: 50 milliseconds

Release Time: 0.1 to 1.1 seconds

Threshold: Adjustable: 0 dBm to -16 dbm output

Compression Ratio: 2:1 at 0 dBm threshold; 4:1 at +16 dBm threshold

Controls: Gain, Threshold, Release Time, Output atten', meter-trim,

Power Supply: 12V AC, 4 Watts

Tubes: 6BC8, 12AU7

Phaedrus Audio Ltd. reserves the right to alter these specifications without notice.

## Declaration of Conformity

The Manufacturer of the Products covered by this Declaration is

**Phædrus Audio Ltd.**  
**head office address**

The directives covered by this declaration are:

**89/336/EEC Electromagnetic Compatibility directive**  
**73/23/EEC Low Voltage Equipment directive**

The products covered by this declaration are:

**Phædrus Audio PHAMULUS - δμ compressor**

The basis on which conformity is being declared:

The manufacturer hereby declares that the products identified above comply with the protection requirements of the EMC directive and with the principal elements of the safety objectives of the Low Voltage Equipment directive, and that the following standards have been applied:

**IEC INTERNATIONAL STANDARD 60065 - Audio, video and similar electronic apparatus - Safety requirements**

The technical documentation required to demonstrate that the products meet the requirements of the Low Voltage Equipment directive has been compiled and is available for inspection by the relevant enforcement authorities. The CE mark was first applied in 2011.



Signed:  
Date:

**Richard Brice, Technical Director**  
October 2011



# Appendix - TEST PRO-FORMA

Product: PHAMULUS      Serial Number: \_\_\_\_\_

Tested by: \_\_\_\_\_

Volts TP1: \_\_\_\_\_      Volts TP2: \_\_\_\_\_

Volts TP3: \_\_\_\_\_      Volts TP4: \_\_\_\_\_

Volts TP5: \_\_\_\_\_      Volts TP6: \_\_\_\_\_ (Comp switch out)

Volts TP1: \_\_\_\_\_ (Comp switch in)      Volts TP7: \_\_\_\_\_

Gain test      Pass / Fail

Compression test:      Pass / Fail

Attenuator test:      Pass / Fail

Frequency response test: HF (-3dB) extension:      Pass / Fail

Frequency response test: LF (-3dB) extension:      Pass / Fail

Phantom (+48) supply test:      Pass / Fail / N/A

Listening test: Pass / Fail

---

# 438C Compressor Amplifier

# 438C

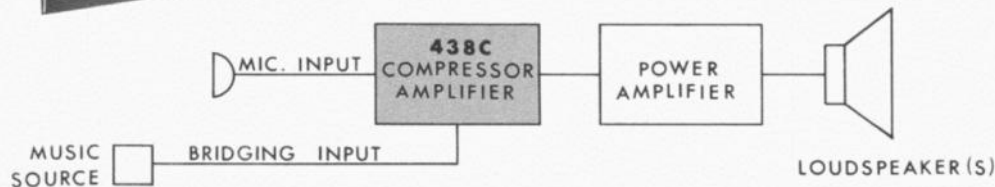

## Features:

- Variable Compression Ratio, Threshold, and Release Time.
- Microphone preamplifier
- Line amplifier
- 90 db gain
- Two inputs
- Fast attack
- Smooth recovery
- 30 db of compression
- Compact
- Fully automatic
- Simple installation

The 438C has been specifically designed for public address use but its outstanding quality also finds many broadcast, recording and communication applications. It is a dual purpose unit providing both high gain microphone preamplification and the complete facility of the Altec automatic compression line amplifier. Its gain and output are such that it will drive any Altec power amplifier to full output from the input of any quality dynamic microphone. Its unique compression assures high intelligibility and freedom from "blasting" or damage to the power amplifier and speakers due to sudden high-level sounds.

The 438C utilizes variable threshold/compression ratio and release time controls, permitting maximum flexibility in virtually any type of installation.

Operationally the 438C will compress signals as much as 30 db. This automatic compression with its rapid attack time of 50 milliseconds, can be used to compensate for the differences in loudness between users in paging or recording and to provide over-all system protection and smoothness. In addition to this microphone input there is a 600 ohm line bridging input for wired music and other program sources. The proper balancing of these two inputs results in automatic "fading" of background music material during paging. Use of the bridging input alone provides straight-forward compression of line program material. Removal of the 6AL5 tube from the circuit permits the 438C to operate as a simple microphone preamplifier and line amplifier without compression.

The hinged front panel of the 438C contains all controls, fuse, pilot light, and compression meter. For remote monitoring of the compressing action the Altec 6049 meter may be ordered. When opened, the front panel exposes all components and wiring for easy service. All connections are made to simple barrier terminals on the rear of the unit. A three conductor power cord is pre-wired for ease of installation.

This outstanding multi-function unit occupies only 3½" of standard rack space or it may be table or wall mounted in the compact Altec 12495 cabinet. The high quality, fully automatic compressor operation and wide range of function are obtained in this Altec amplifier at an extremely low price which makes it economically sound to use the 438C instead of less effective simple preamplifiers and line amplifiers.



A Division of B&W Ling Altec, Inc.

1515 S. Manchester Ave., Anaheim, Calif.  
New York